

# LM60T Laser Tape User Manual

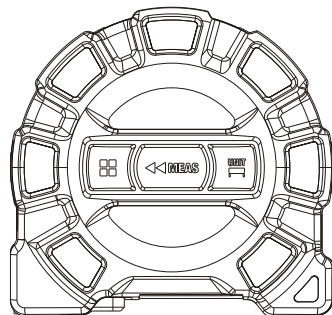

## Product Overview

Thank you for purchasing the new LM60T laser tape. In order to use this product safely and correctly, please read this manual thoroughly, especially the Safety Instructions part.

LM60T is a 2 in 1 multifunctional tool that combines tape measurement and laser measurement. This product conforms to the MID II standard accuracy. It has a strong blade with 1.8m stand-out. It also has a magnetic hook to measure metal materials conveniently, and a tape lock to draw back the tape safely.

## ⚠ Safety Instructions

LASER RADIATION, DO NOT STARE INTO BEAM,  
CLASS 2 LASER PRODUCT



## Caution

- Do not direct the laser beam at persons and do not look directly into the laser beam. Do not use the optics lens to stare into the laser beam.
  - This product complies with strict standards and regulations, but the possibility of interference with other equipment cannot be completely ruled out, and it may cause discomfort to humans and animals.
- \* Do not use this product in an explosive or corrosive environment.
  - \* Do not use this product near medical equipment.
  - \* Do not use this product on an airplane.

### 1) Waste disposal:

Do not dispose of used batteries together with domestic garbage. Dispose of them at the designated garbage collection station instead. This product cannot be recycled with domestic garbage. Please dispose of it according to the laws and regulations of the country/region.

### 2) Limitation of liability:

Our company will not be responsible for any loss caused by using the instrument not in accordance with this manual, using third-party accessories or modifying the instrument.

## Charging instructions

This product has a built-in lithium battery. Please use the original USB cable to plug into a power socket to charge, or connect to a computer for charging, but it will take longer.

## Caution

During the charging process, the product may heat up, which is a normal phenomenon and will not affect its performance and service life. If the charger is not used for a long time, please unplug it.

## Product Appearance

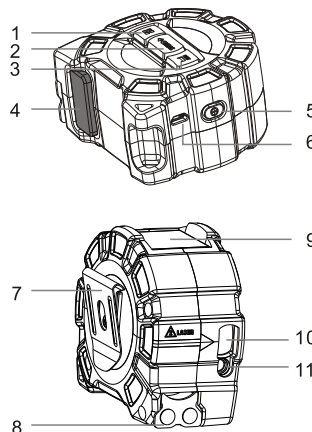

### 1. Menu

Short press to switch between measurement modes. Long press to view the historical measurement data and short press again to view the next data.

### 2. Measure

Short press to take a measurement. Long press to switch to continuous measurement.

### 3. Unit conversion/measurement reference

Short press to convert units: m/ft/in/". Long press to switch the measurement reference.  
\* The front reference is the side of the magnetic hook.  
\* The rear reference is the side of the power button.

### 4. Tape lock

Press the tape lock to control the speed of drawing back the tape.

### 5. Power

Long press to power on/off. Short press to return to the previous step.

### 6. Micro USB interface

### 7. Metal buckle

### 8. Tape/magnetic hook

### 9. Display

### 10. Laser receiving aperture

### 11. Laser emission aperture

## LCD Indicators/Icons

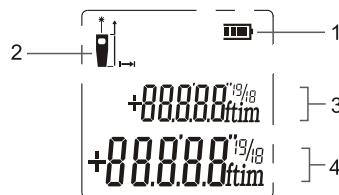

- Battery status
- Measurement reference (front/rear reference)
- Historical measurement data
- Current measurement data

## Laser Measurement

### 1) Single measurement

When the product is turned on, it will enter into the single measurement mode by default. Aim the laser at the measurement target and press ◀◀MEAS, and the measured value will show on the screen. Press ◀◀MEAS again to take the next measurement.

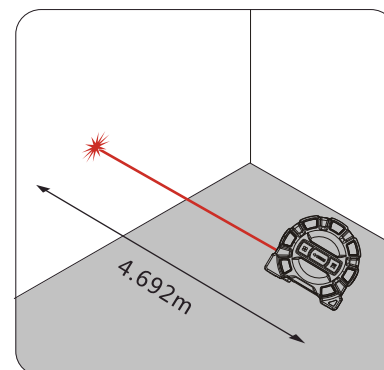

### 2) Continuous measurement

Long press ◀◀MEAS to enter into the continuous measurement mode. Move the laser tape left and right or up and down. Press ◀◀MEAS to stop measuring.

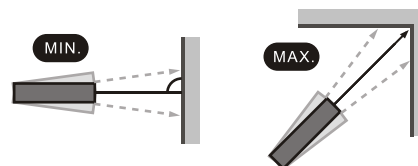



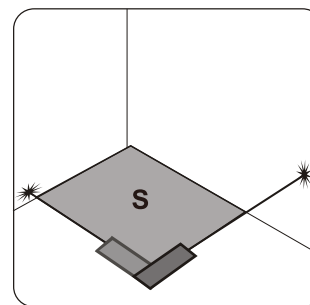

### 3) Area measurement

Short press ■ to switch to the area measurement mode ▱. A side of the ▱ icon will flash. Aim the laser at the first point of the measurement target, and press ◀◀MEAS to measure the length of the first side (length). Then another side of the ▱ icon will flash. Aim the laser at the second point, and press ◀◀MEAS again to measure the length of the second side (width). The area calculation result will be displayed at the bottom of the screen.



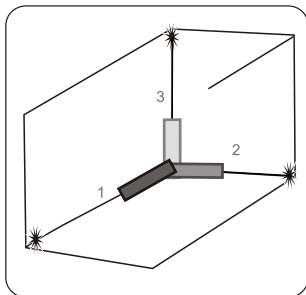

#### 4) Volume measurement

Short press **MEAS** to switch to the volume measurement mode . A side of the  icon will flash. Aim the laser at the first point of the measurement target, and press **MEAS** to measure the length of the first side (length). The second side of the  icon will flash. Aim the laser at the second point, and press **MEAS** again to measure the length of the second side (width). Then the third side of the  icon will flash. Aim the laser at the third point, and press **MEAS** again to measure the length of the third side (height). The volume calculation result will be displayed at the bottom of the screen.



#### 5) Two-point Pythagorean measurement

Short press **MEAS** to switch to the two-point Pythagorean measurement mode . A side of the  icon will flash. Aim the laser at the first point of the measurement target, and press **MEAS** to measure the length of the first side (hypotenuse). Move the laser tape to the second point which is on the same horizontal line as the first point. Press **MEAS** to measure the length of the second side. The calculation result will be displayed at the bottom of the screen.

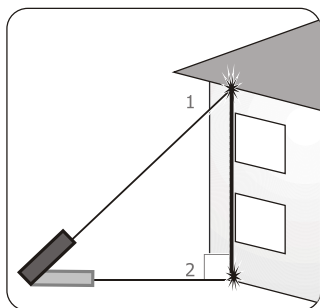

### Tape Measurement

#### 1) Movable hook

The movable hook is a professional design used for zero point correction to ensure the measurement accuracy.

Measurement method A: inside measurement

Take the outer surface of the hook as the base point of zero scale. The hook will move backward and retract slightly after being supported. The retracted length is the thickness of the hook.

Measurement method B: outside measurement

Take the inner side of the hook as the base point of zero scale. After the hook is hooked, it will move backward slightly.

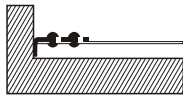

Measurement method A:  
Inside measurement

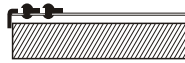

Measurement method B:  
Outside measurement

#### 2) Magnetic hook

It can be attached to metal materials to measure the length.



#### 3) Tape lock

Press the tape lock to draw back the tape slowly, and release it to stop drawing back.

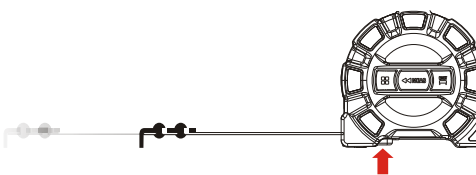

### Specifications

Model	LM60T
Product name	Laser tape
Tape range	5m
Tape accuracy	Grade II
Tape coating thickness	0.13mm
Magnetic hook	√
Brake switch material	ABS
Braking method	Automatically lock
Metal buckle	√
Laser range	0.2-60m
Laser accuracy	±(2.0mm+5×10 <sup>-5</sup> D)
Units	m/ft/in <sup>'''</sup>
Laser class	Class 2
Laser type	630-670nm, < 1mW
Single measurement	√
Continuous measurement	√
Area measurement	√
Volume measurement	√
Two-point Pythagorean measurement	√
Measurement reference	Front/rear reference
Battery life	5000 measurements
Battery status	√
Display	EBTN
Built-in lithium battery	350mAh
Historical measurement data	20 groups
Laser auto off	30s
Auto power off	3 minutes
Product size	85*56.3*81.5mm
Product weight	300g

#### 1. Range

The range takes the rear reference as a reference by default. The maximum range will change according to different models and versions. The actual range is shown in the outer packaging of the product.

#### 2. Accuracy (D is the measured length)

Under good measurement conditions (measurement surface, room temperature, indoor light, etc.), the rated range can be reached. Under poor measurement conditions, such as excessive light, weak reflection on the surface of the measured object, or excessive temperature difference, the error will increase.

Note: In the case of poor sunlight or target reflection, please use a sight vane or a better reflective surface.

### Troubleshooting

Code	Cause	Solution
204	Calculation error	Follow the user manual to operate again.
220	Low battery	Please replace the battery or charge the product.
255	Weak received reflected light or overlong measurement time	Improve the reflective surface (use reflector, white paper, etc.).
256	Strong received signal	Improve the reflective surface (use reflector, or do not aim at strong light).
261	Over range	Please measure within the range of the product.
500	Hardware malfunction	If the same problem still occurs after turning the product on/off multiple times, please contact the dealer.

**UNI-T**

UNI-TREND TECHNOLOGY (CHINA) CO., LTD.

No. 6, Gong Ye Bei 1st Road,  
Songshan Lake National High-Tech Industrial  
Development Zone, Dongguan City,  
Guangdong Province, China

